

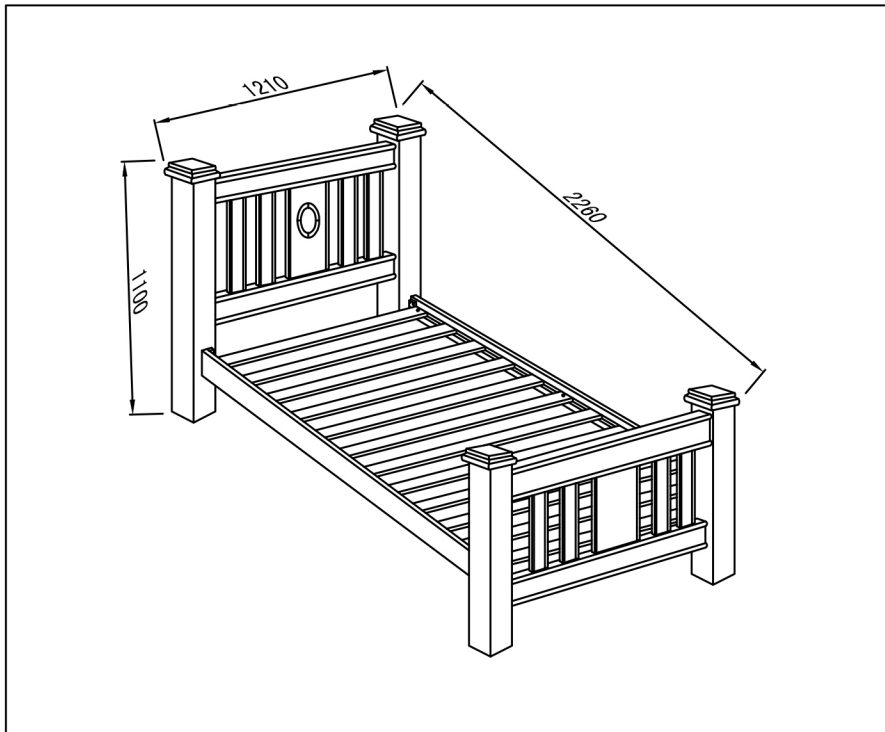

**ASSEMBLY INSTRUCTION
TULLY JUMBO SINGLE BED.
ITEM CODE - 52985.**

Imported by Amart Furniture Pty Ltd, QLD, Brisbane Australia.
For any assistance with assembly or for missing parts please
phone Amart Furniture, Customer service Freecall 1800 351 084.







**Imported by Amart Furniture Pty Ltd, QLD, Brisbane Australia.
For any assistance with assembly or for missing parts please
phone Amart Furniture, Customer service Freecall 1800 351 084.**

PRE-ASSEMBLY PREPARATION

BEFORE YOU START...

1. Choose a clean, level, spacious assembly area. Avoid hard surfaces that may damage the product.
2. Check and ensure that you have all required contents for complete assembly.
3. Always read the assembly instructions carefully before beginning assembly.
4. The packaging and contents can be a choking hazard, therefore keep out of reach of small children at all times.
5. Do not over tighten the bolts as this may damage the thread.

	
ALLOW 20 MINUTES	2 PEOPLE REQUIRED
 	
ADDITIONAL TOOLS REQUIRED	

PARTS LIST

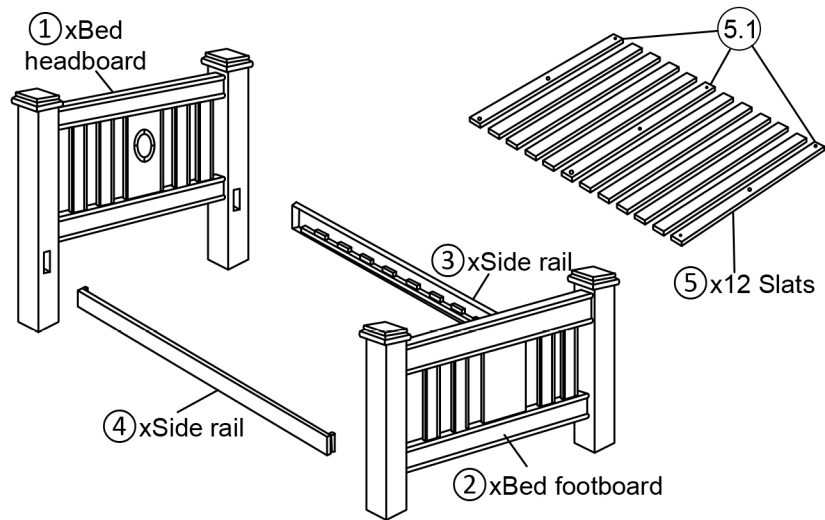

1	HEADBOARD
2	FOOTBOARD
3	SIDE RAIL
4	SIDE RAIL
5	SLATS (1085mm x 90mm)

a. Long Screw M4mmx40mm 6 PCS 	b. Short Screw M6mmx10mm 8 PCS 	c. Allen Key 1 PCS 
--	---	--

STEP 1: Fasten the side rails (3)(4) to bed headboard (1) with short screws (b).
 (b). Fasten the side rails (3)(4) to bed footboard (2) with short screws (b).

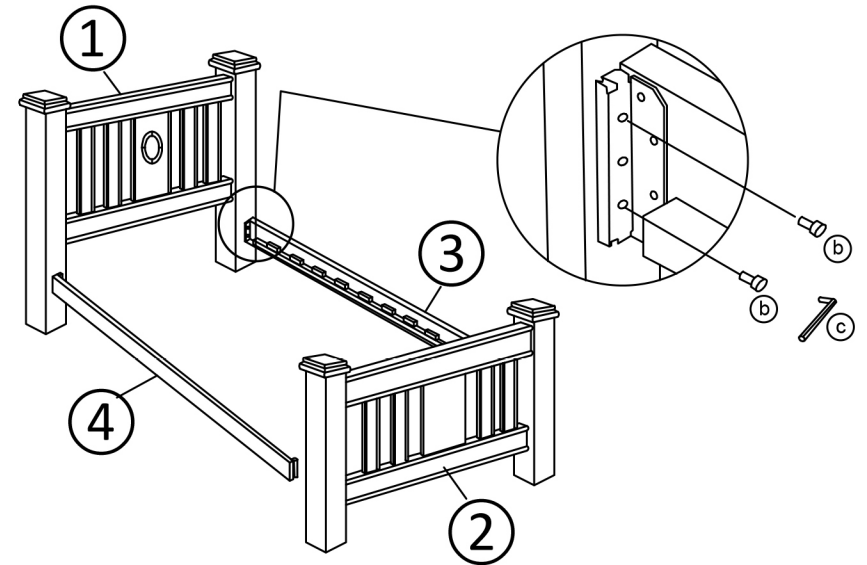

STEP 2: Mount bed slats with holes (5.1) one at the beginning of bed, centre and end. Fasten down screws (a) with screwdriver. Mount remaining slats (5) to the bed frame. Assembly is complete.

